

QT-Brightek PLCC Series

PLCC4 White LED

Part No.: QBLP1515-IW5-XX

XX = WW/NW/CW

Product: QBLP1515-IW5-XX	Date: December 11, 2017	Page 1 of 11
	Version# 1.2	

Table of Contents:

Introduction	3
Electrical / Optical Characteristic (T=25 °C)	4
Absolute Maximum Rating	4
Correlated Color Temperature Chart	6
Characteristic Curves.....	7
Solder Profile & Footprint.....	8
Packing	9
Labeling	10
Ordering Information	10
Disclaimer	11

Introduction

Feature:

- Package in tape and reel
- Ultra bright reflector type PLCC4 LED
- InGaN technology for White
- 120 degree viewing angle

Description:

These ultra bright reflector type PLCC4 LEDs have a height profile of 1.00mm. With a combination of high brightness output and robust package, these LEDs are ideal for architecture lighting, status indication, and industrial equipment lighting applications.

Application:

- Status indication
- Industrial equipment backlighting
- Architecture lighting

Certification & Compliance:

- TS16949
- ISO9001
- RoHS Compliant



Dimension:

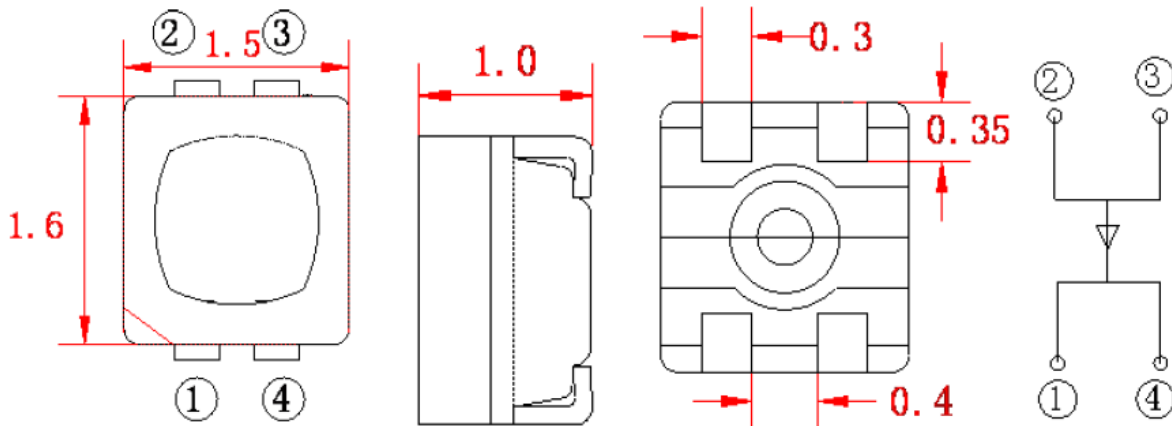

Units: mm / tolerance = +/-0.2mm

Electrical / Optical Characteristic (T=25 °C)

Product	Color	I _F (mA)	V _F (V)		CCT(K)			I _V (mcd)	
			Typ.	Max.	Min.	Typ.	Max.	Min.	Typ.
QBLP1515-IW5-WW	Warm White	5	2.9	3.4	2760	3000	3260	290	450
QBLP1515-IW5-NW	Natural White	5	2.9	3.4	3640	4000	4240	290	490
QBLP1515-IW5-CW	Cool White	5	2.9	3.4	5300	6020	7050	290	530

Absolute Maximum Rating

Material	P _d (mW)	I _F (mA)	I _{FP} (mA)*	V _R (V)	T _{OP} (°C)	T _{ST} (°C)	T _{SO L} (°C)**
InGaN	55	15	60	5	-30 to +85	-40 to +85	260

*Duty 1/10 @ 1KHz

** IR Reflow for no more than 10 sec @ 260 °C

Forward Voltage V_F @ I_F=5mA

Bin	Min.	Max.	Unit
e	2.5	2.8	V
f	2.8	3.1	
g	3.1	3.4	

Luminous Intensity I_V for Warm White (WW) @ I_F=5mA

Bin	Min.	Max.	Unit
23	290	380	mcd
24	380	490	
25	490	640	

Luminous Intensity I_V for Natural White (NW) @ I_F=5mA

Bin	Min.	Max.	Unit
23	290	380	mcd
24	380	490	
25	490	640	

Luminous Intensity I_V for Cool White (CW) @ I_F=5mA

Bin	Min.	Max.	Unit
23	290	380	mcd
24	380	490	
25	490	640	

Note:

Tolerance of measurement of forward voltage: ±0.1V

Tolerance of measurement of luminous intensity: ±15%

Correlated Color Temperature (CCT) @ I_F=5mA

Bin	Min.	Max.	Unit
RN	2760	3260	K
RL	3640	4240	
RM	5300	6020	
RR	6020	7050	

Correlated Color Temperature Chart

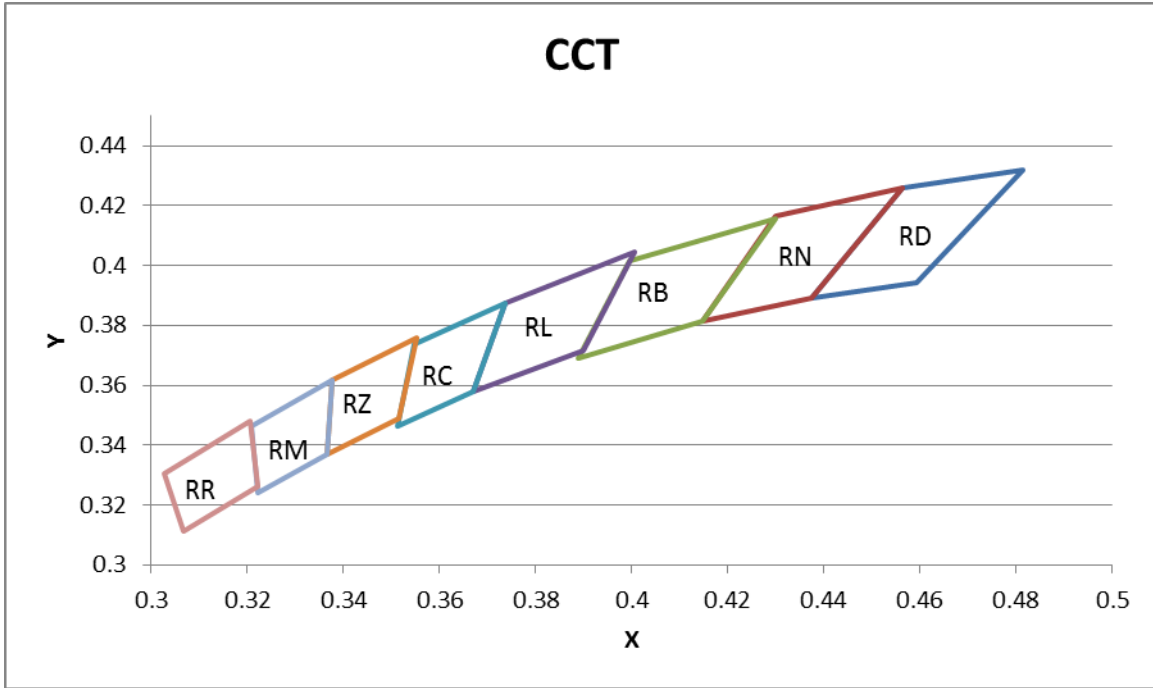

Color Ranks @ I _F =5mA							
RD		RN		RB		RL	
0.4813	0.4319	0.4562	0.426	0.4299	0.4156	0.4006	0.4044
0.4562	0.426	0.4299	0.4165	0.3996	0.4015	0.3736	0.3874
0.4373	0.3893	0.4147	0.3814	0.3889	0.369	0.367	0.3578
0.4593	0.3944	0.4373	0.3893	0.4147	0.3814	0.3898	0.3716
0.4813	0.4319	0.4562	0.426	0.4299	0.4156	0.4006	0.4044
RC		RZ		RM		RR	
0.3736	0.3874	0.3551	0.376	0.3376	0.3616	0.3205	0.3481
0.3548	0.3736	0.3376	0.3616	0.3207	0.3462	0.3028	0.3304
0.3512	0.3465	0.3366	0.3369	0.3222	0.3243	0.3068	0.3113
0.367	0.3578	0.3515	0.3487	0.3366	0.3369	0.3221	0.3261
0.3736	0.3874	0.3551	0.376	0.3376	0.3616	0.3205	0.3481

Note:
Tolerance of measurement of color coordinates: ±0.01

Characteristic Curves

FORWARD CURRENT VS. FORWARD VOLTAGE

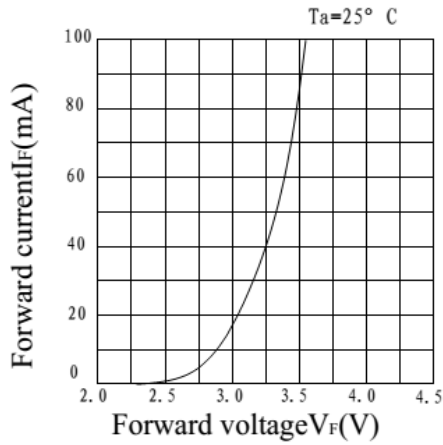

RELATIVE LUMINOUS INTENSITY VS. FORWARD CURRENT

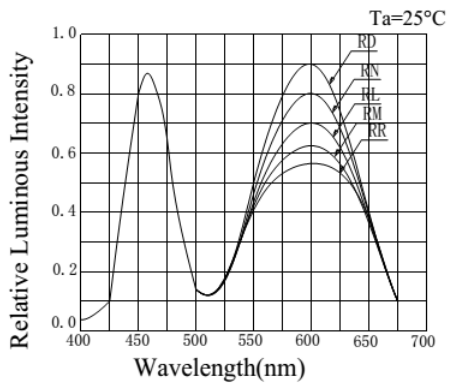
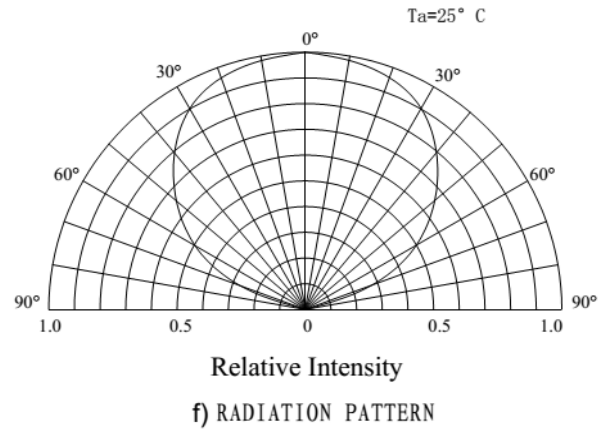
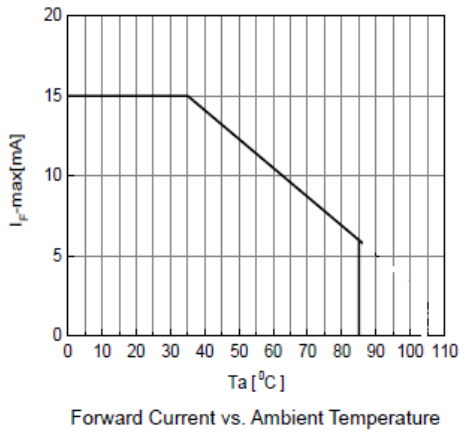
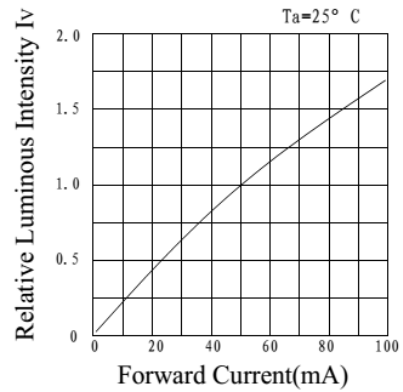

e) RELATIVE INTENSITY VS. WAVELENGTH

Solder Profile & Footprint

- Recommended tin solder specifications: melting temperature in the range of 178~192 °C
- The recommended reflow soldering profile is as follows (temperatures indicated are as measured on the surface of the LED resin):

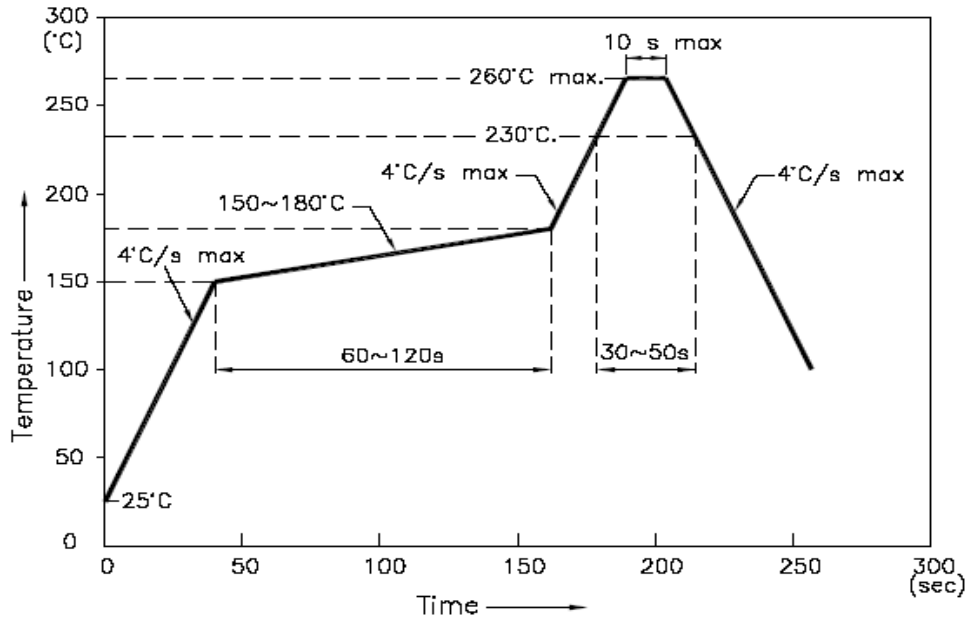

Recommended Pad Layout

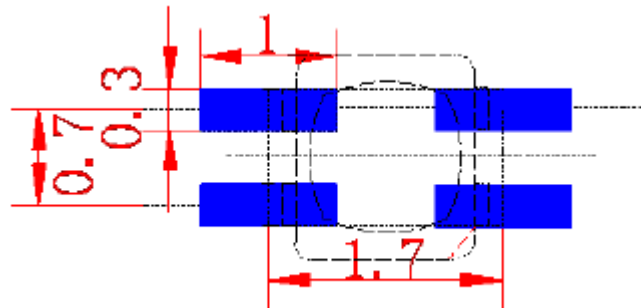

Units: mm

Tolerance: ± 0.2mm

Packing

Reel Dimension:

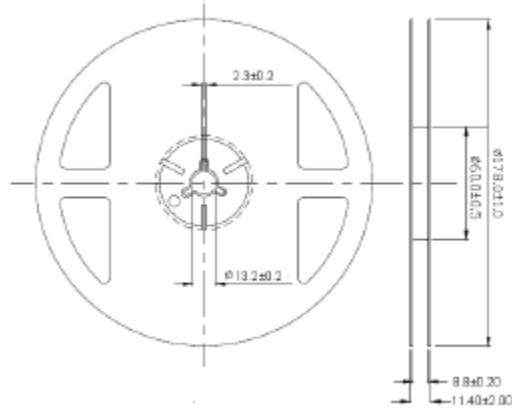

Unit: mm

Tape Dimension:

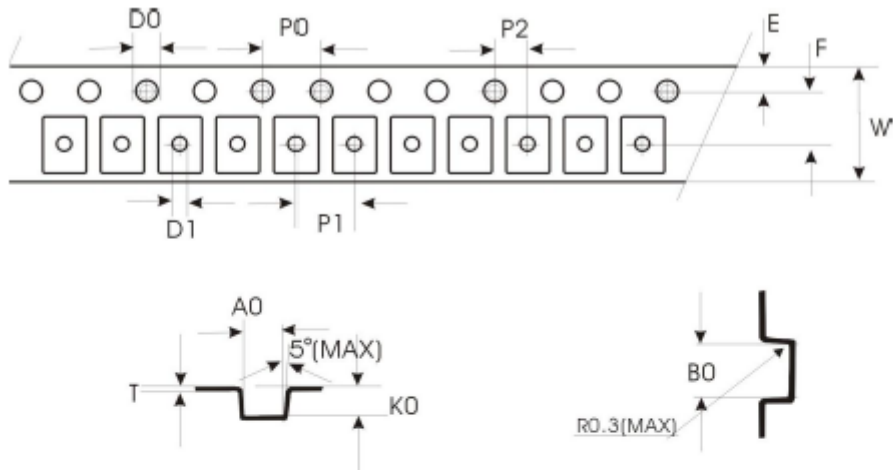

Symbol	A0	B0	K0	P0	P1	P2	T
Spec	1.8±0.1	1.85±0.1	1.2±0.1	4.0±0.1	4.0±0.1	2.00±0.1	0.25±0.05
Symbol	E	F	D0	D1	W	P0	
Spec	1.75±0.10	3.50±0.05	1.5±0.1	1.0±0.1	8.0±0.1	40.0±0.2	

Unit: mm

Packaging Specifications:

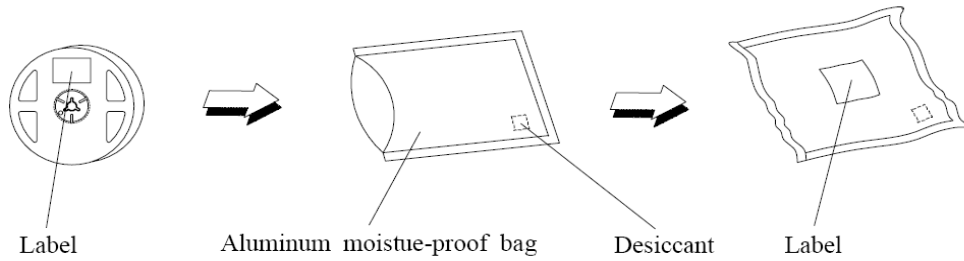
**Labeling**

Part No: _____
Customer P/N: _____
Item: _____
Q'ty: _____
Vf: _____
Iv: _____
WI: _____
Date: _____

Made in China**Ordering Information**

Part #	Orderable Part #	Spec Range	Quantity per reel
QBLP1515-IW5-WW	QBLP1515-IW5-WW	Iv=450 mcd typ. @ 5mA / CCT=2760-3260K	4,000 units
QBLP1515-IW5-NW	QBLP1515-IW5-NW	Iv=490 mcd typ. @ 5mA / CCT=3640-4240K	4,000 units
QBLP1515-IW5-CW	QBLP1515-IW5-CW	Iv=530 mcd typ. @ 5mA / CCT=5300-7050K	4,000 units

Revision History

Description:	Revision #	Revision Date
New Release of QBLP1515-IW5-XX	V1.0	11/17/2015
Amend the brightness of CW	V1.1	03/15/2016
Update packing spec to 3500pcs per reel	V1.2	12/11/2017

Disclaimer

QT-BRIGHTTEK reserves the right to make changes without further notice to any products herein to improve reliability, function or design. QT-BRIGHTTEK does not assume any liability arising out of the application or use of any product or circuit described herein; neither does it convey any license under its patent rights, nor the rights of others.

Life Support Policy

QT-BRIGHTTEK's products are not authorized for use as critical components in life support devices or systems without the express written approval of QT-BRIGHTTEK. As used herein:

1. Life support devices or systems are devices or systems which, (a) are intended for surgical implant into the body, or (b) support or sustain life, and (c) whose failure to perform when properly used in accordance with instructions for use provided in the labeling, can be reasonably expected to result in a significant injury of the user.
2. A critical component in any component of a life support device or system whose failure to perform can be reasonably expected to cause the failure of the life support device or system, or to affect its safety or effectiveness.