

QT-Brightek UV LED Series

UVC LED

Part No.: QBHP684E-UV265X

**UV265 : Wavelength
X: 20mA or 100mA**

Product: QBHP684E-UV265 Series	Date: August 12, 2020	Page 1 of 10
Preliminary	Version# 1.0	

Table of Contents:

Introduction	3
Electrical / Optical Characteristic (Ta=25 °C)	4
Absolute Maximum Rating	4
Characteristic Curves.....	5
IR Reflow Soldering Profile	7
Packing	8
Labeling	9
Caution	9
Ordering Information	9
Revision History	10
Disclaimer	10

Introduction

Feature:

- UVC LED
- Clear Lens
- Packed in tape and reel
- ESD rating: 8KV (HBM)
- Viewing Angle: 120°

Description:

This UV LED has compact size of 3.5 x 3.5mm. It is ideal for various UV applications.

Application:

- UV marking
- Purification
- Inspection
- Sterilization and Disinfection

Certification & Compliance:

- TS16949
- ISO9001
- RoHS Compliant



Outline Dimensions:

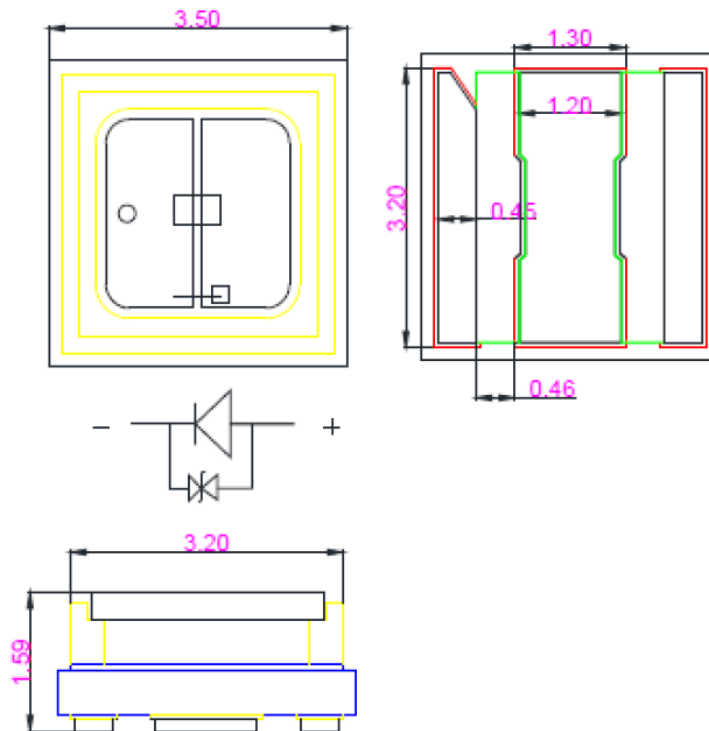

Units: mm / tolerance = +/-0.2mm

Electrical / Optical Characteristic (Ta=25 °C)

Part Number	Color	I _F (mA)	V _F (V)			λ _p (nm)			P _o (mW)		
			Min.	Typ.	Max.	Min.	Typ.	Max.	Min.	Typ.	Max.
QBHP684E-UV265	UVC	20	5.0	6.0	6.5	260	265	270	1.6	2.5	-
QBHP684E-UV265N	UVC	100	5.0	6.0	6.5	260	265	270	7	10	-

Absolute Maximum Rating

Part Number	P _d (mW)	I _F (mA)	T _{OP} (°C)	T _{ST} (°C)	T _{SO L} (°C)
QBHP684E-UV265	260	40	-10 to +50	-40 to +100	260
QBHP684E-UV265N	1000	150	-10 to +50	-40 to +100	260

Tolerance of measurement of forward voltage: ±0.1V

Tolerance of measurement of Radiometric Power: ±10%

Tolerance of measurement of dominant wavelength: ±5nm

Characteristic Curves

QBHP684E-UV265

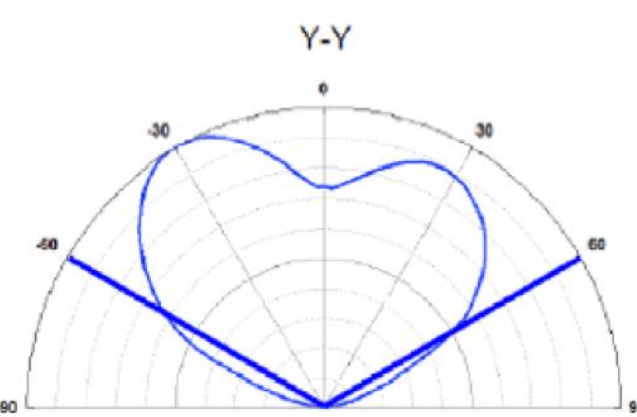
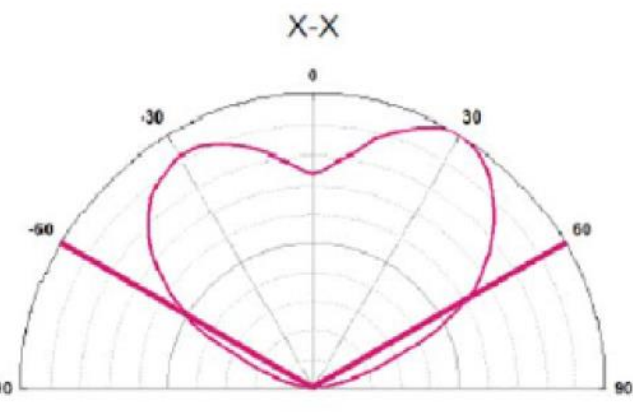
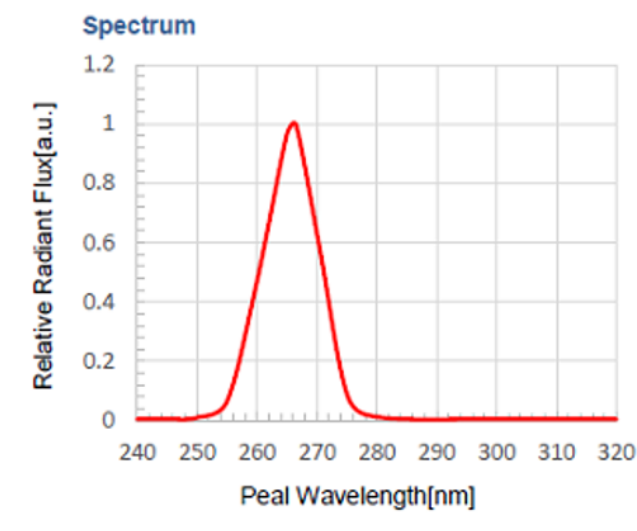
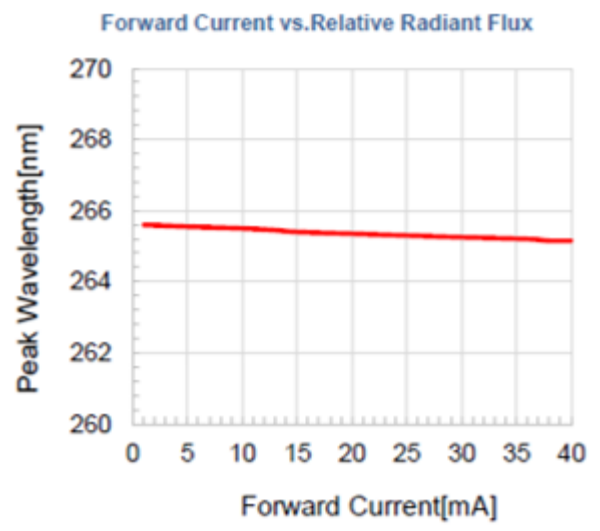
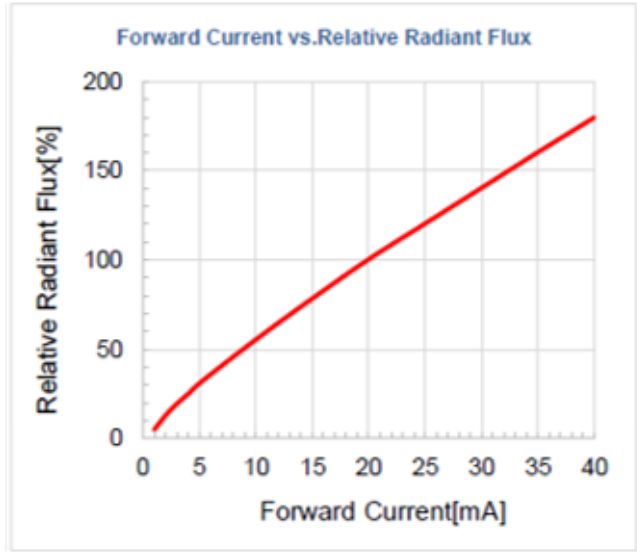
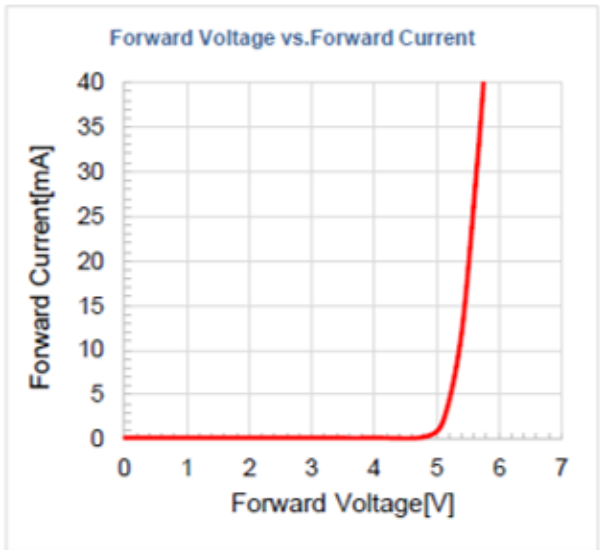

QBHP684E-UV265N

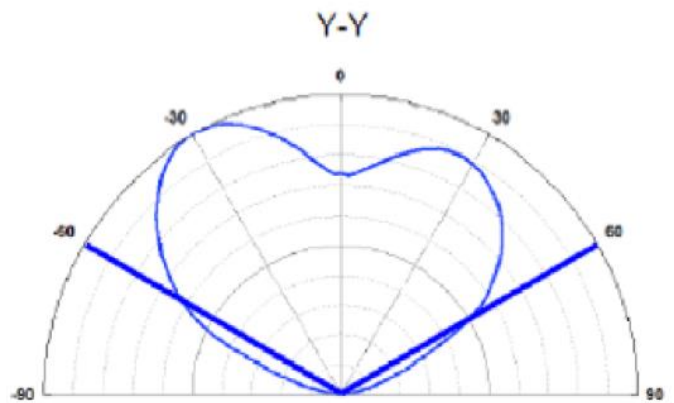
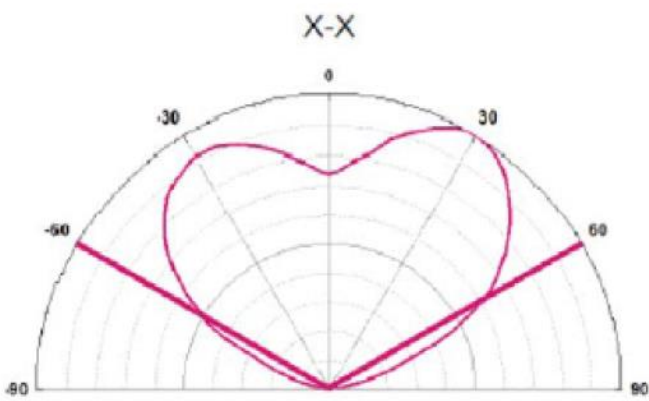
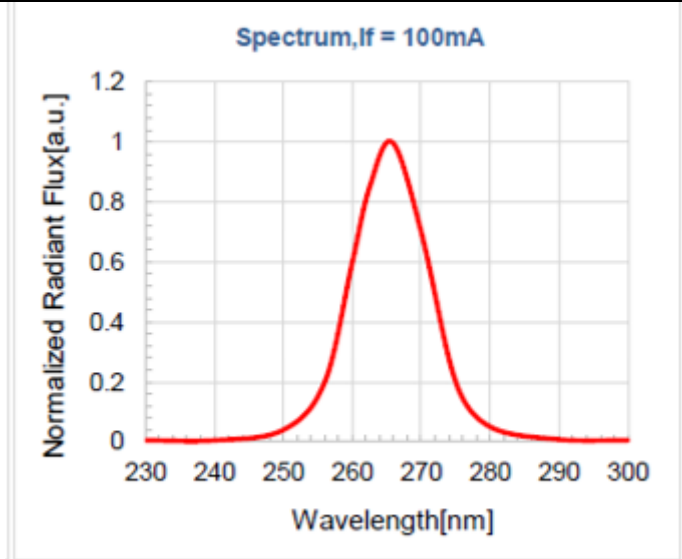
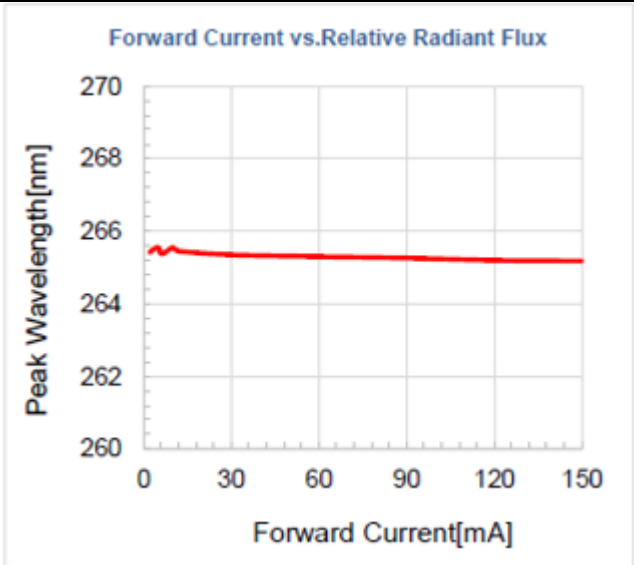
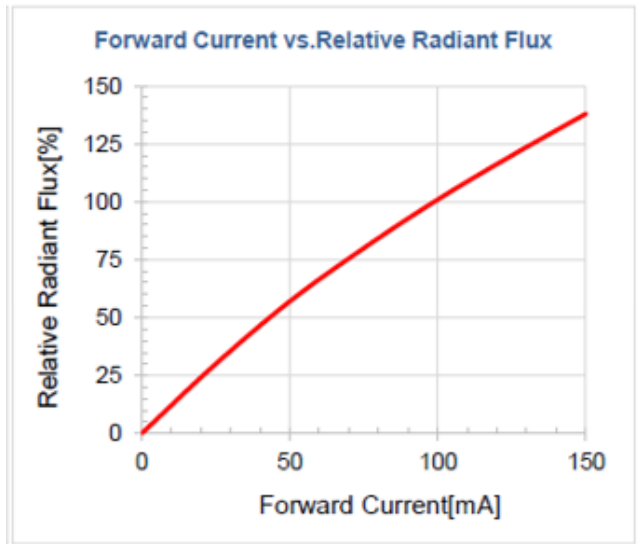
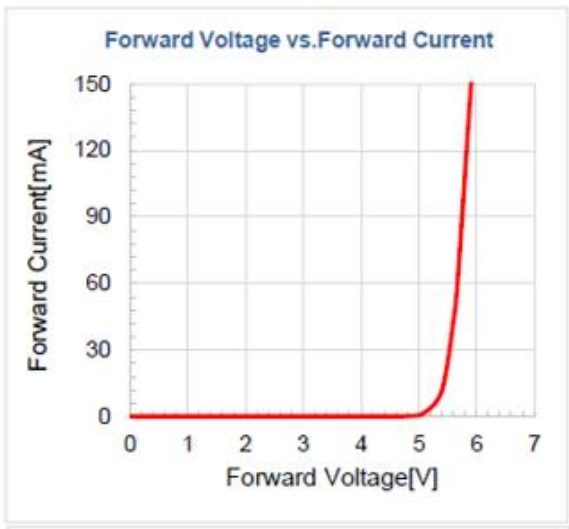

IR Reflow Soldering Profile

Lead Free solder

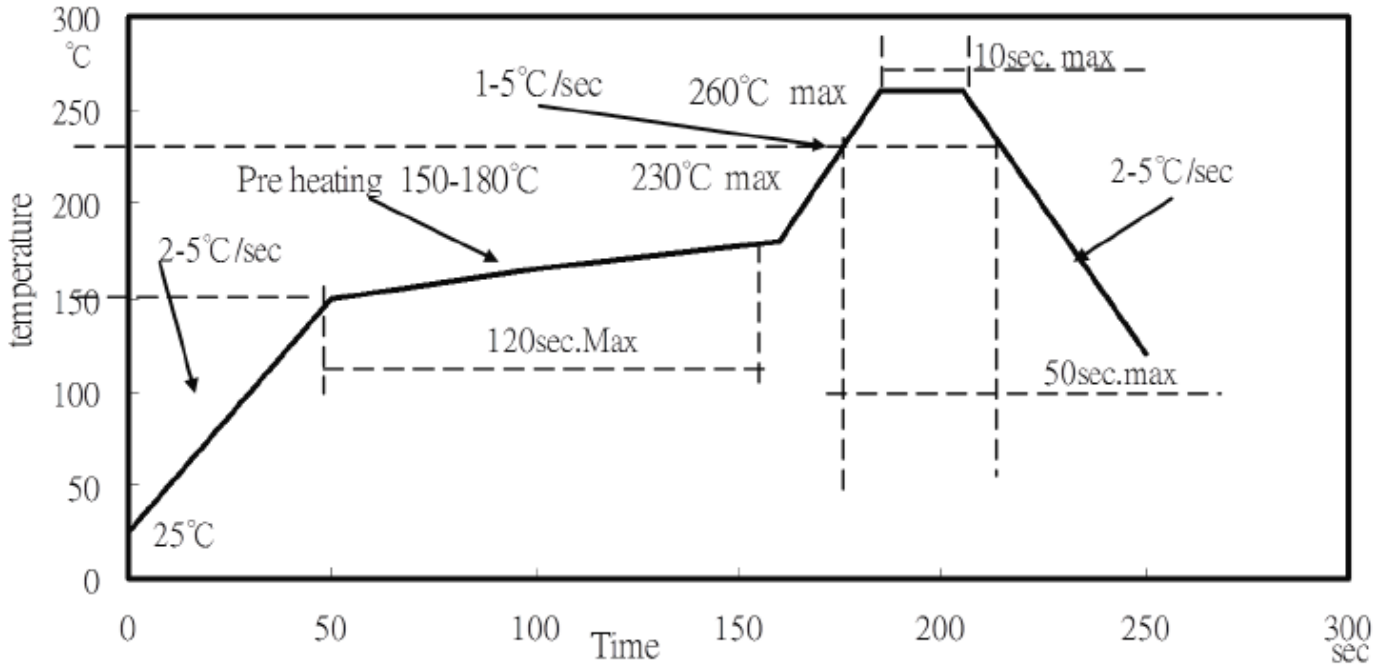

Recommended Soldering Pad:

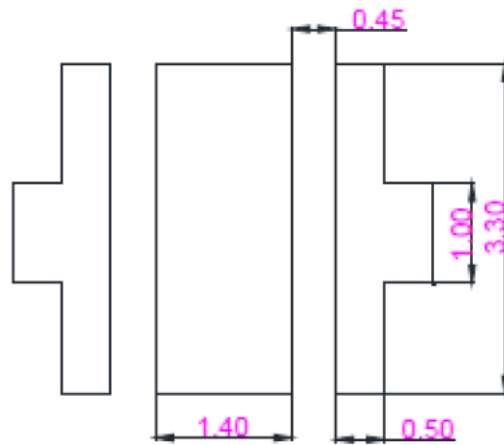

Unit: mm

Product: QBHP684E-UV265 Series	Date: August 12, 2020	Page 7 of 10
Preliminary	Version# 1.0	

Packing

Tape and Reel:

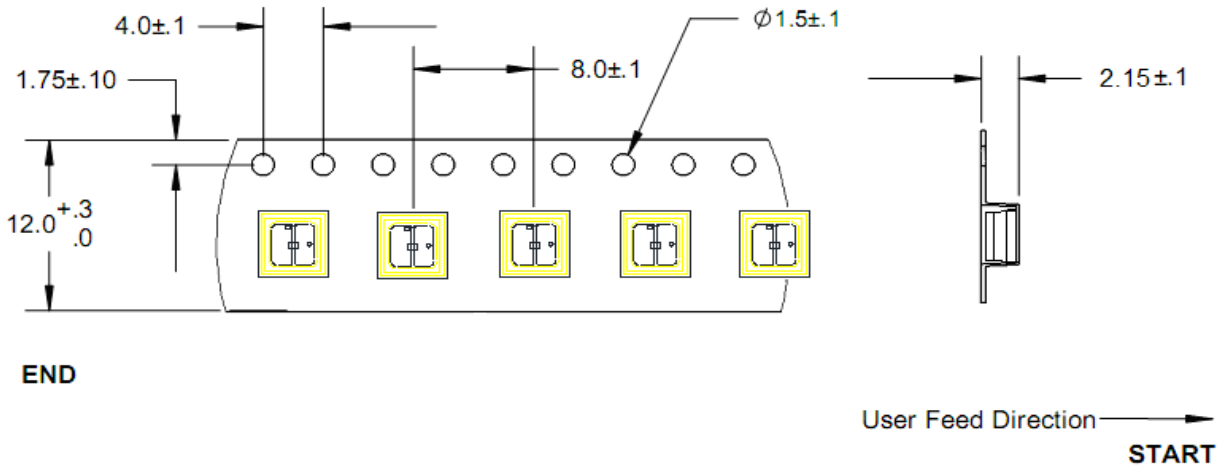

10 bag/box

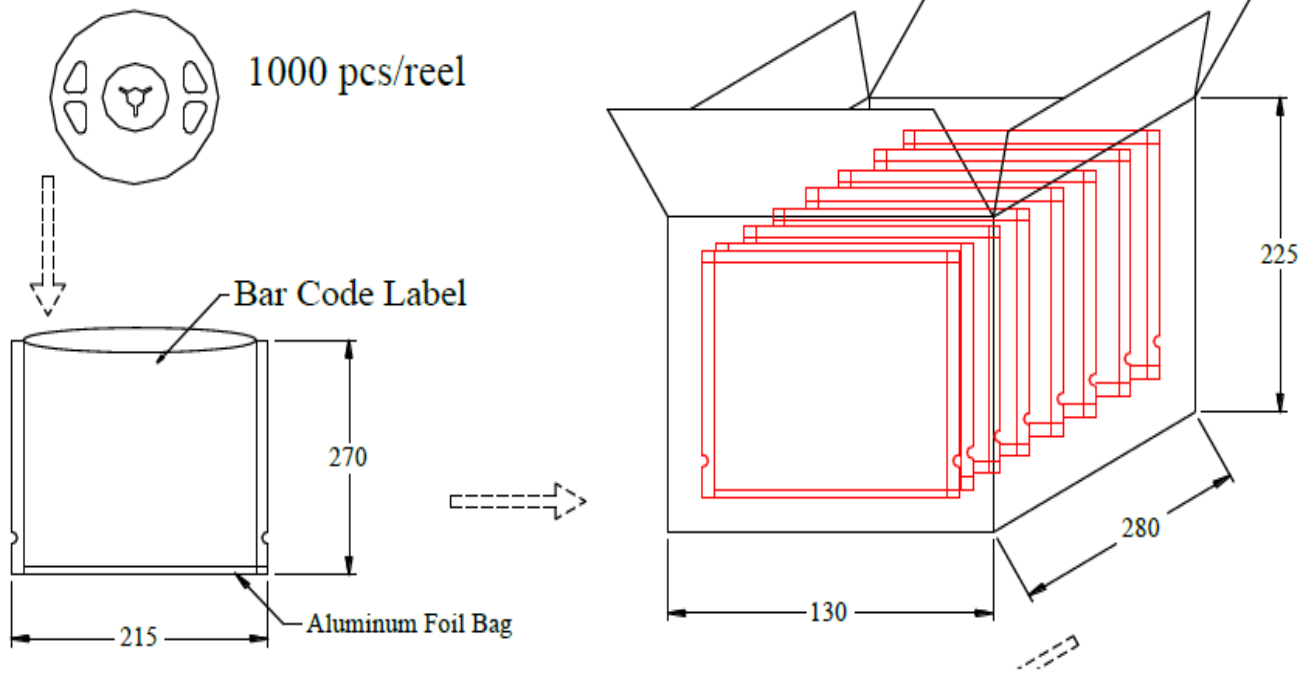

Labeling



Part No: _____

Customer P/N: _____

Item: _____

Q'ty: _____

Vf: _____

Iv: _____

WI: _____

Date: _____

Made in China

Caution

	<div style="text-align: center;"> <h1 style="margin: 0;">CAUTION</h1> </div> <ul style="list-style-type: none"> This UV LED during operation radiates intense UV light. Do not look directly into the UV light during operation of the device. This can be harmful to the eyes even for brief period due to the intense UV light. If viewing the UV light is necessary, please use UV filtered glasses to avoid damage by the UV light. If the UV LED in your product might be viewed directly, please affix a caution label to your product to that effect. <p style="text-align: center;">Avoid direct eye exposure to UV light Keep out of reach of children</p>
--	---

Ordering Information

Part #	Orderable Part #	Spec Range	Quantity per reel
QBHP684E-UV265	QBHP684E-UV265	Po=2.5mW @ If=20mA, λp=265nm typ.	1000 units
QBHP684E-UV265N	QBHP684E-UV265N	Po=10mW @ If=100mA, λp=265nm typ.	1000 units

Revision History

Description:	Revision #	Revision Date
New Release of QBHP684E-UV265 Series	V1.0	08/12/2020

Disclaimer

QT-BRIGHTTEK reserves the right to make changes without further notice to any products herein to improve reliability, function or design. QT-BRIGHTTEK does not assume any liability arising out of the application or use of any product or circuit described herein; neither does it convey any license under its patent rights, nor the rights of others.

Life Support Policy

QT-BRIGHTTEK's products are not authorized for use as critical components in life support devices or systems without the express written approval of QT-BRIGHTTEK. As used herein:

1. Life support devices or systems are devices or systems which, (a) are intended for surgical implant into the body, or (b) support or sustain life, and (c) whose failure to perform when properly used in accordance with instructions for use provided in the labeling, can be reasonably expected to result in a significant injury of the user.
2. A critical component in any component of a life support device or system whose failure to perform can be reasonably expected to cause the failure of the life support device or system, or to affect its safety or effectiveness.