

QT-Brightek PLCC Series

Dome Type PLCC4 LED

Part No.: QBLP677AD-XXM

AD = Common Anode with Dome Lens

XX = Color Code

M = 30mA Sorting

Product: QBLP677AD-XXM	Date: November 22, 2021	Page 1 of 11
	Version# 1.1	

Table of Contents:

Introduction	3
Electrical / Optical Characteristic (Ta=25 °C)	4
Absolute Maximum Rating	4
Characteristic Curves.....	6
Solder Profile & Footprint.....	7
Handling Precautions.....	8
Packing	9
Labeling	10
Ordering Information	10
Revision History	11
Disclaimer	11

Introduction

Feature:

- Water clear lens
- Ultra bright PLCC4 LED
- InGaN technology
- Viewing Angle: 30° typ.
- Common Anode
- MSL 3

Description:

These PLCC4 white LEDs have a height profile of 3.6mm. Combination of high brightness output and robust package, this LED is ideal for architecture lighting, status indication, and color mixing applications.

Application:

- Status indication
- Industrial equipment backlighting
- Signage
- Display

Certification & Compliance:

- ISO9001
- RoHS Compliant



Dimension:

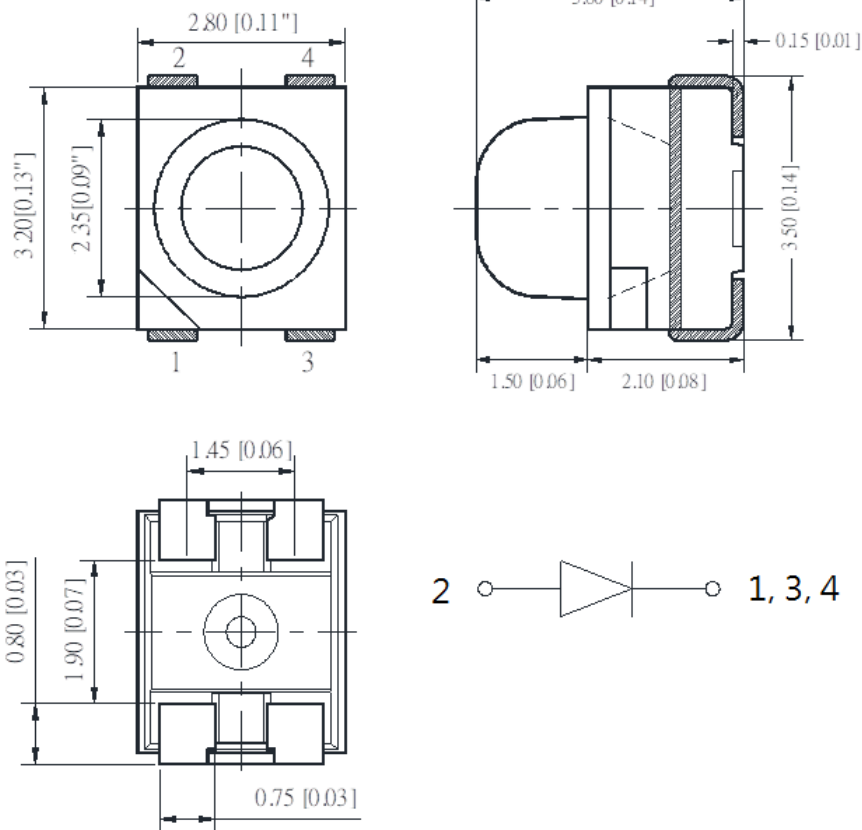

Units: mm / tolerance = +/-0.2mm

Electrical / Optical Characteristic (Ta=25 °C)

Product	Color	I _F (mA)	V _F (V)		λ _D (nm)			I _V (mcd)	
			Typ.	Max.	Min.	Typ.	Max.	Min.	Typ.
QBLP677AD-IGM	True Green	30	3.0	3.7	515	520	530	6800	14000
QBLP677AD-IBM	Blue	30	3.3	3.7	460	465	470	1000	1800

Absolute Maximum Rating

Material	P _d (mW)	I _F (mA)	I _{FP} (mA)*	V _R (V)	T _{OP} (°C)	T _{ST} (°C)	T _{SO L} (°C)**
InGaN (IGM)	148	40	125	5	-40 ~ +90	-40 ~ +90	240
InGaN (IBM)	111	30	125	5	-40 ~ +85	-40 ~ +85	240

*Duty 1/8 @ 1KHz

**IR Reflow for no more than 8 sec @ 240 °C

Forward Voltage V_F for True Green (IGM) @ I_F=30mA

Bin	Min.	Max.	Unit
f	2.8	3.1	V
g	3.1	3.4	
h	3.4	3.7	

Forward Voltage V_F for Blue (IBM) @ I_F=30mA

Bin	Min.	Max.	Unit
g	2.8	3.1	V
h	3.1	3.4	
i	3.4	3.7	

Luminous Intensity I_V for Green (IGM) @ I_F=30mA

Bin	Min.	Max.	Unit
b	6800	8800	mcd
c	8800	11200	
d	11200	14200	
e	14200	18000	
f	18000	22500	

Luminous Intensity I_V for Blue (IBM) @ I_F=30mA

Bin	Min.	Max.	Unit
T	1000	1250	mcd
U	1250	1600	
V	1600	2000	
W	2000	2500	
X	2500	3200	

Dominant Wavelength λ_D for True Green (IGM) @ $I_F=30mA$

Bin	Min.	Max.	Unit
S	515	517.5	nm
T	517.5	520	
U	520	522.5	
V	522.5	525	
W	525	527.5	
X	527.5	530	

Dominant Wavelength λ_D for Blue (IBM) @ $I_F=30mA$

Bin	Min.	Max.	Unit
E	460	462.5	nm
F	462.5	465	
G	465	467.5	
H	467.5	470	

Characteristic Curves

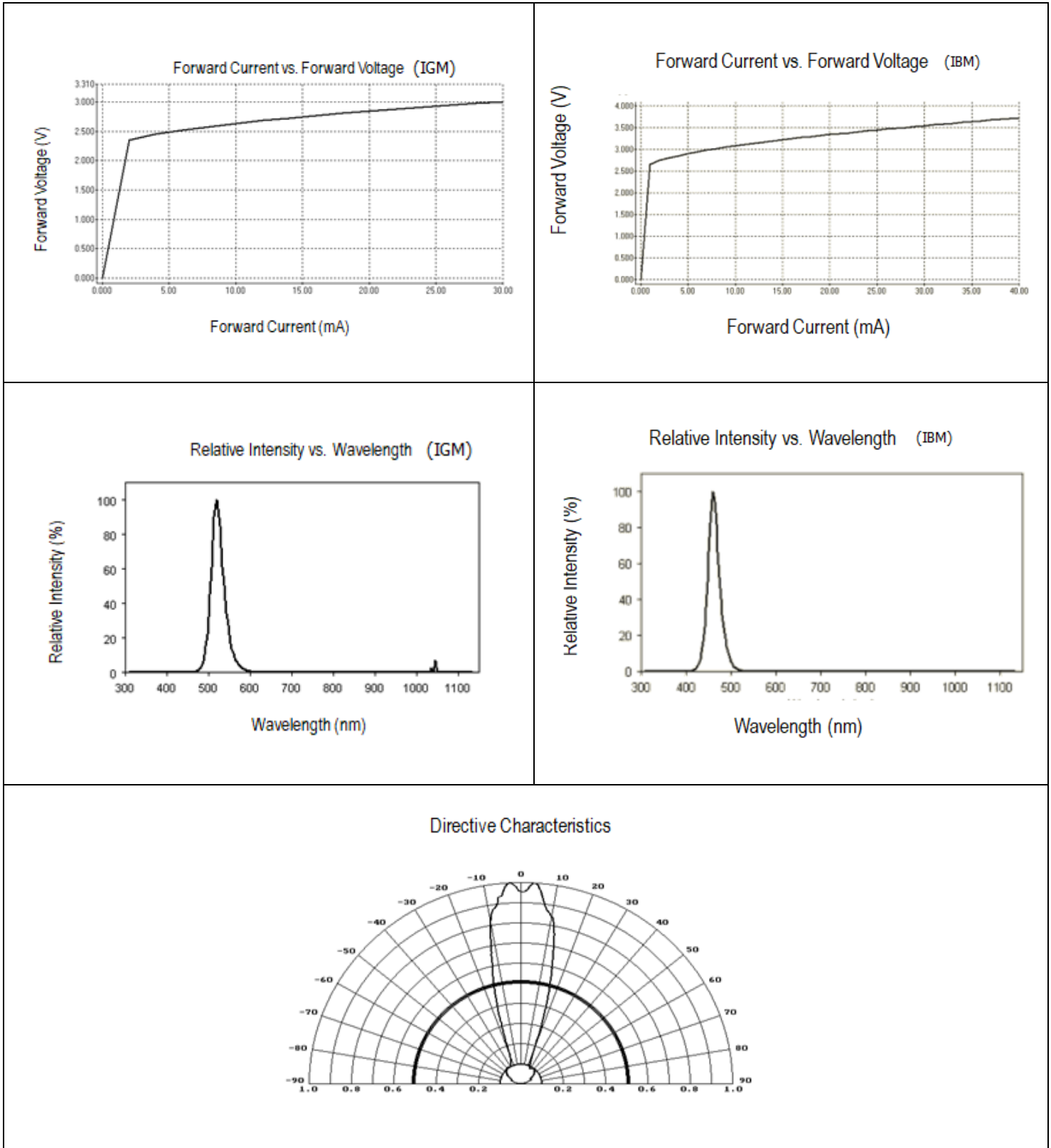

Solder Profile & Footprint

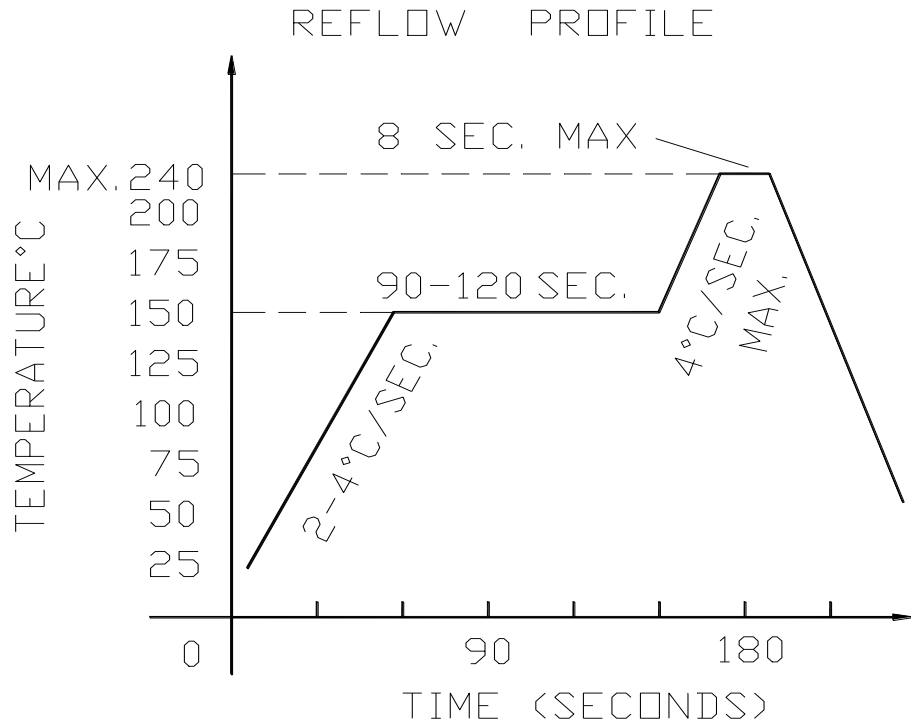

Recommend Pad Layout

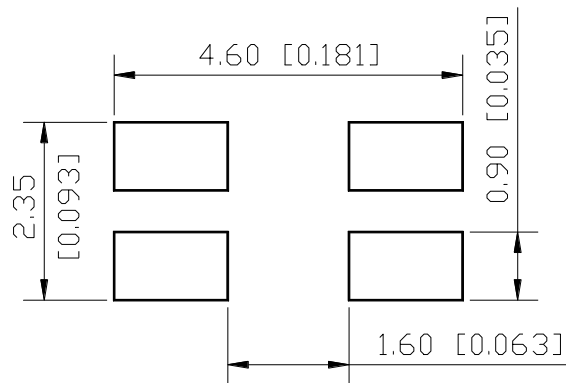

Units: mm

Handling Precautions

1. It is recommended to store the products in sealed and anti-static bags with desiccant inside at the following condition:
 - Humidity: <60% RH
 - Temperature: 5°C~30°C
2. Shelf life in sealed bag: 12 month at 5°C~30°C and < 60% R.H
3. After the package is opened:
 - 3.1 The products should be used within a week (168 hours)
 - 3.2 Or product should be stored at $\leq 20\%$ RH and (5°C~30°C) with zip-lock sealed bag
 - 3.3 It is recommended to bake before soldering when the package is unsealed after 72hrs;
 - 3.3.1 Baking condition (Tape and Reel Type): $60\pm 3^\circ\text{C}$ (24~36 hrs) and < 5% RH
 - 3.4 Products require baking before soldering/mounting if **3.1** or **3.2** is not met. Baking condition refers to **3.3.1**
4. If the product is not used within 3 months since manufacturing date, it is recommended to bake for 24 hrs @ 60°C before use.
5. If the product is not used after 3 months since manufacturing date, it is recommended to bake for 36~48 hrs @ 60°C before use.

Product: QBLP677AD-XXM	Date: November 22, 2021	Page 8 of 11
	Version# 1.1	

Packing

Reel Dimension:

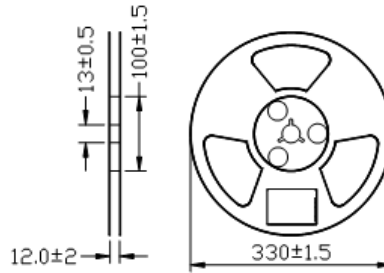

Unit: mm

Dimensions of Tape:

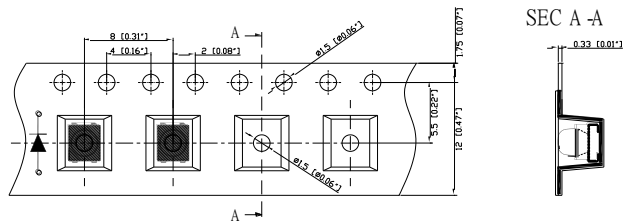

Unit: mm

Arrangement of Tape:

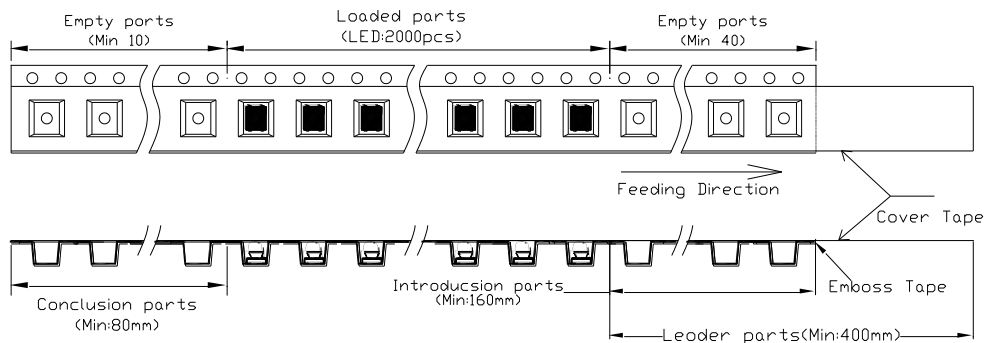

Packaging Specifications:

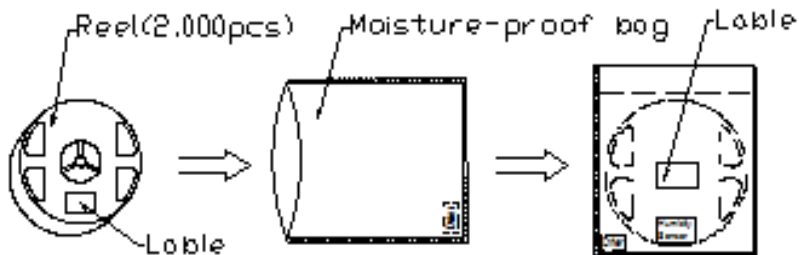

Labeling

Part No: _____

Customer P/N: _____

Item: _____

Q'ty: _____

Vf: _____

Iv: _____

VI: _____

Date: _____

Made in China**Ordering Information**

Part #	Orderable Part #	Spec Range	Quantity per Reel
QBLP677AD-IGM	QBLP677AD-IGM	Iv=14000mcd typ., @ If=30mA, λD=515nm to 530nm	2000 units
QBLP677AD-IBM	QBLP677AD-IBM	Iv=1800mcd typ., @ If=30mA, λD=460nm to 470nm	

Revision History

Description:	Revision #	Revision Date
New Release of QBLP677AD-XXM	V1.0	10/20/2017
Update brightness for IGM	V1.1	11/22/2021

Disclaimer

QT-BRIGHTTEK reserves the right to make changes without further notice to any products herein to improve reliability, function or design. QT-BRIGHTTEK does not assume any liability arising out of the application or use of any product or circuit described herein; neither does it convey any license under its patent rights, nor the rights of others.

Life Support Policy

QT-BRIGHTTEK's products are not authorized for use as critical components in life support devices or systems without the express written approval of QT-BRIGHTTEK. As used herein:

1. Life support devices or systems are devices or systems which, (a) are intended for surgical implant into the body, or (b) support or sustain life, and (c) whose failure to perform when properly used in accordance with instructions for use provided in the labeling, can be reasonably expected to result in a significant injury of the user.
2. A critical component in any component of a life support device or system whose failure to perform can be reasonably expected to cause the failure of the life support device or system, or to affect its safety or effectiveness.