

QT-Brightek PLCC Series

Dome Type PLCC4 LED

Part No.: QBLP677BD-IBD-2897

**BD: Common Cathode with Dome Lens
D: 50mA Testing Current
2897: High Bright**



Table of Contents:

Introduction 3

Electrical / Optical Characteristic (Ta=25 °C) 4

Absolute Maximum Rating 4

Characteristic Curves..... 5

Solder Profile & Footprint..... 6

Handling Precautions..... 7

Packing 8

Labeling 9

Ordering Information 9

Revision History 10

Disclaimer 10

Introduction

Feature:

- Water clear lens
- Ultra bright PLCC4 LED
- Common cathode
- Viewing Angle: 30° typ.
- MSL 3
- Height profile: 3.6mm

Application:

- Warning light
- Emergency light
- Architecture lighting

Certification & Compliance:

- ISO9001
- RoHS Compliant



Dimension:

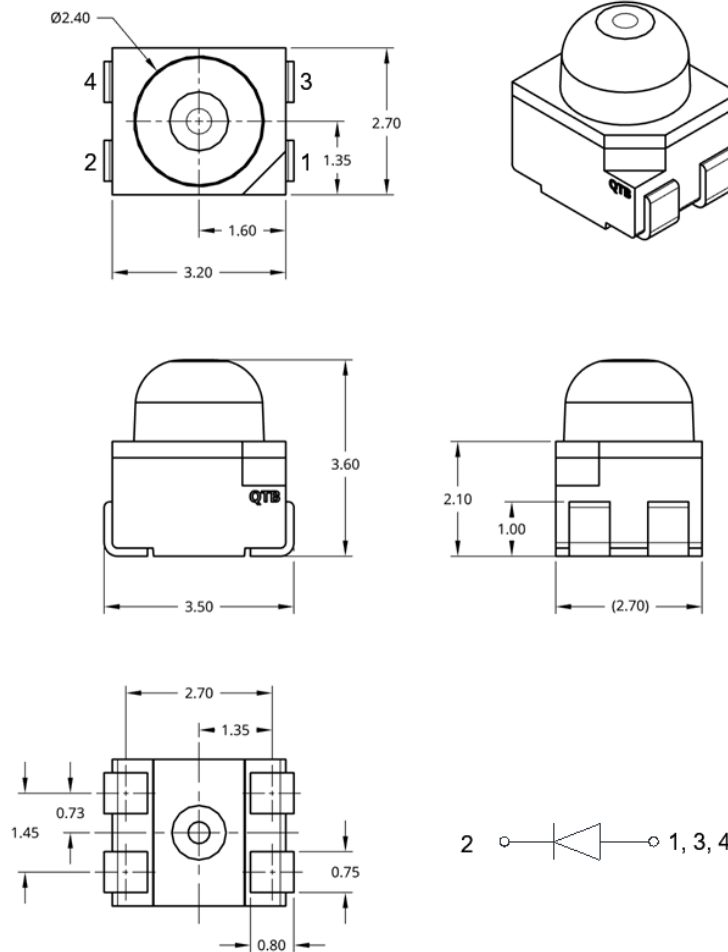

Units: mm / tolerance = +/-0.2mm

Electrical / Optical Characteristic (Ta=25 °C)

Product	Color	I _F (mA)	V _F (V)		λ _D (nm)			λ _P (nm)	I _V (mcd)	
			Typ.	Max.	Min.	Typ.	Max.	Typ.	Min.	Typ.
QBLP677BD-IBD-2897	Blue	50	2.8	3.4	465	468	475	465	3000	6200

Absolute Maximum Rating

Chip Material	P _d (mW)	I _F (mA)	I _{FP} (mA)*	V _R (V)	T _{OP} (°C)	T _{ST} (°C)	T _{SO L} (°C)**
InGaN	340	100	180	5	-40 ~ +85	-40 ~ +90	240

*Duty 1/10 @ 1KHz

**IR Reflow for no more than 8 sec @ 240 °C

Forward Voltage V_F @ I_F=50mA

Bin	Min.	Max.	Unit
e	2.5	2.8	V
f	2.8	3.1	
g	3.1	3.4	

Luminous Intensity I_V @ I_F=50mA

Bin	Min.	Max.	Unit
X	3000	3841	mcd
Y	3841	4800	
Z	4800	6250	
a	6250	8166	
b	8166	10565	

Dominant Wavelength λ_D @ I_F=50mA

Bin	Min.	Max.	Unit
G	465	467.5	nm
H	467.5	470	
I	470	472.5	
J	472.5	475	

Characteristic Curves

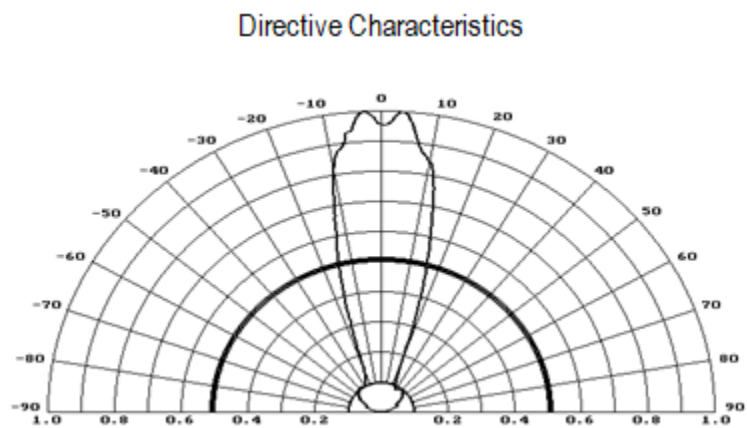
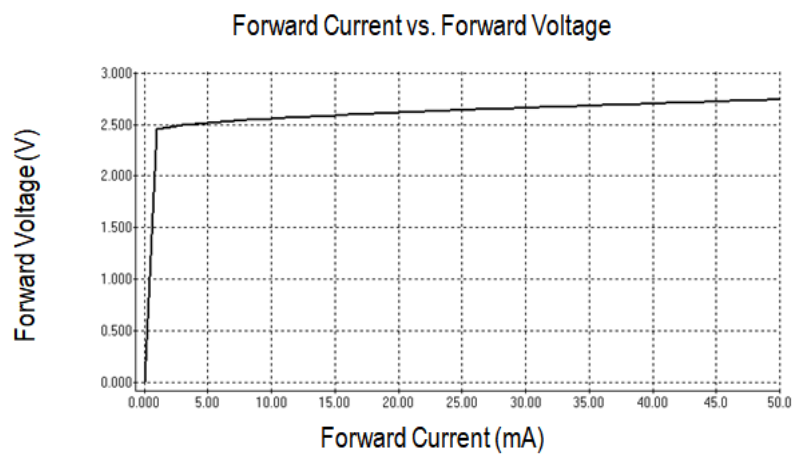
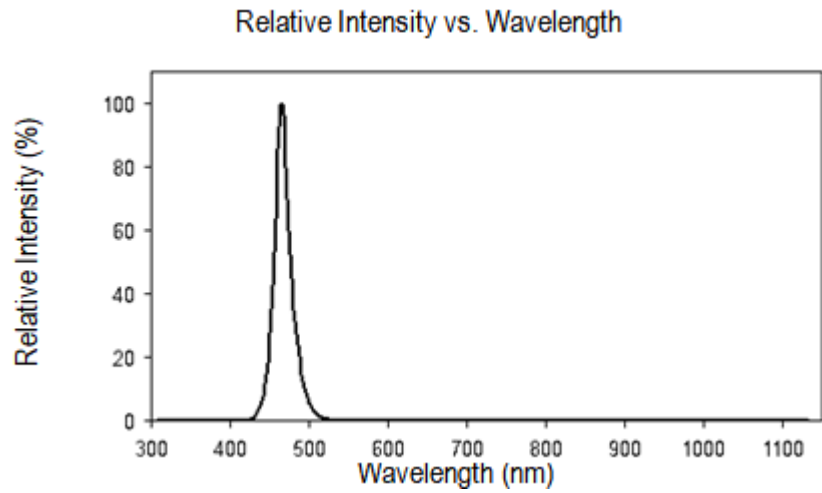

Solder Profile & Footprint

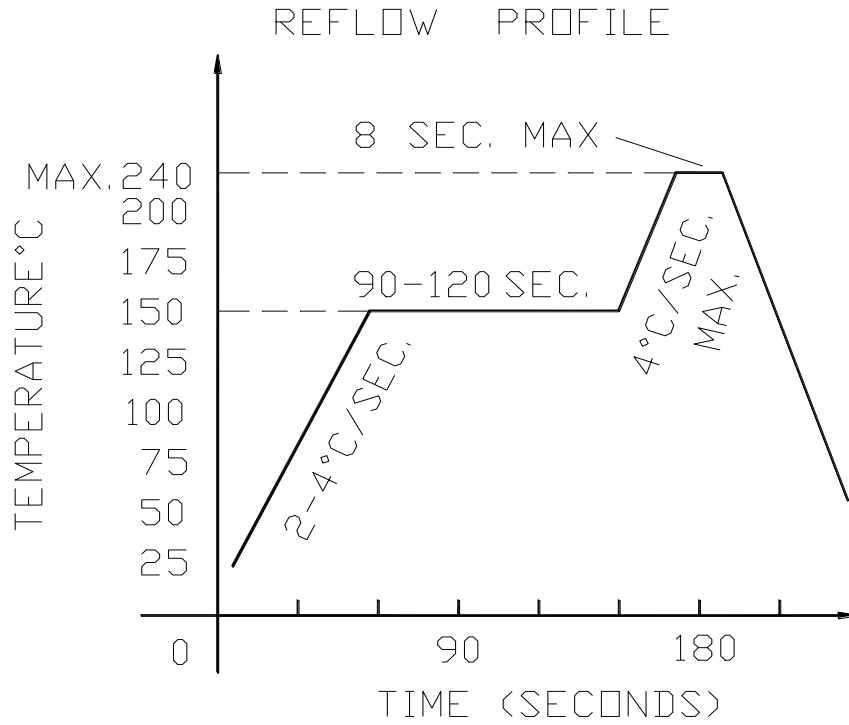

Recommend Pad Layout

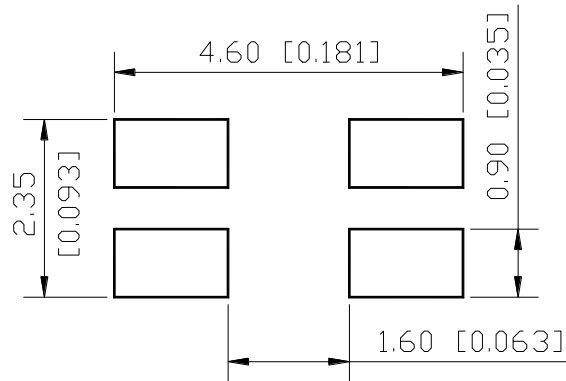

Units: mm

Handling Precautions

1. It is recommended to store the products in sealed and anti-static bags with desiccant inside at the following condition:

- Humidity: <60% RH
- Temperature: 5°C~30°C

2. Shelf life in sealed bag: 12 month at 5°C~30°C and <60% R.H

3. After the package is opened:

3.1 The products should be used within a week (168 hours)

3.2 Or product should be stored at $\leq 20\%$ RH and (5°C~30°C) with zip-lock sealed bag

3.3 It is recommended to bake before soldering when the package is unsealed after 72hrs;

3.3.1 Baking condition (Tape and Reel Type): $60\pm 3^\circ\text{C}$ (24~36 hrs) and < 5% RH

3.4 Products require baking before soldering/mounting if **3.1** or **3.2** is not met. Baking condition refers to **3.3.1**

4. If the product is not used within 3 months since manufacturing date, it is recommended to bake for 24 hrs @ 60°C before use.

5. If the product is not used after 3 months since manufacturing date, it is recommended to bake for 36~48 hrs @ 60°C before use.

Product: QBLP677BD-IBD-2897	Date: November 26, 2025	Page 7 of 10
	Version# 1.0	

Packing

Reel Dimension:

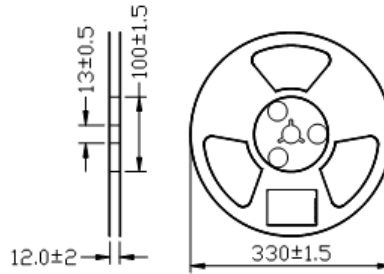

Unit: mm

Dimensions of Tape:

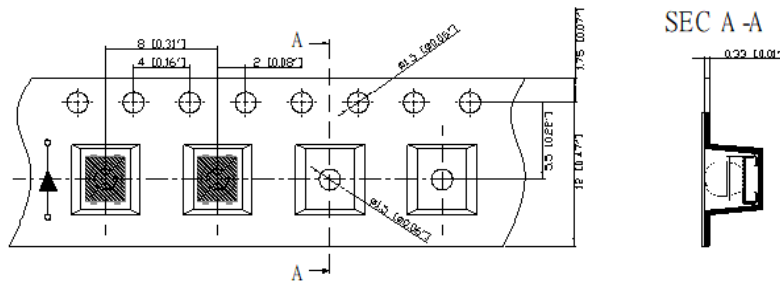

Unit: mm

Arrangement of Tape:

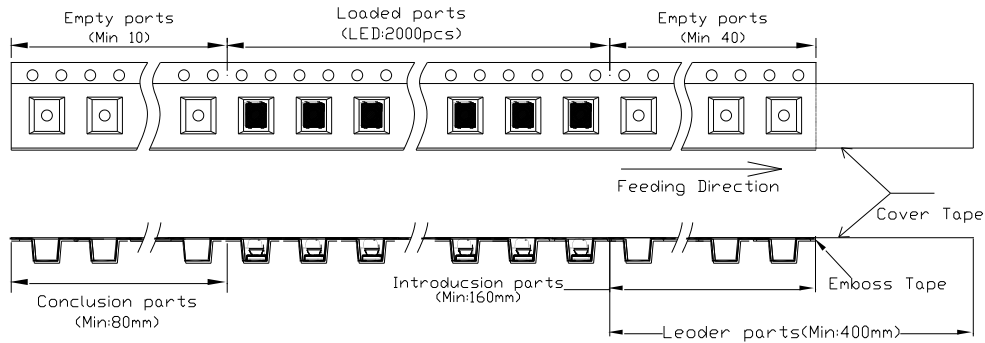

Packaging Specifications:

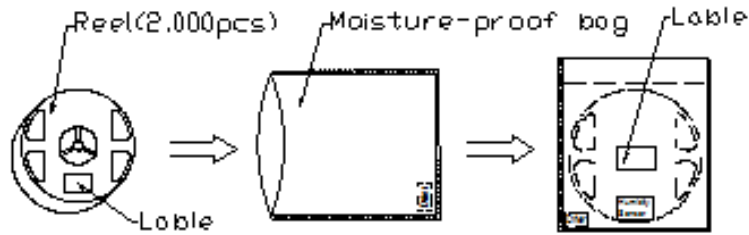

Labeling



Part No: _____
Customer P/N: _____
Item: _____
Q'ty: _____
Vf: _____
Iv: _____
WI: _____
Date: _____

Made in China

Ordering Information

Orderable Part #	Spec Range	Quantity per Reel
QBLP677BD-IBD-2897	Iv=6200mcd typ., $\lambda_D=465\text{nm to }475\text{nm}$ @ $I_F=50\text{mA}$	2000 units



Revision History

Description:	Revision #	Revision Date
New Release of QBLP677BD-IBD-2897	V1.0	07/07/2025

Disclaimer

QT-BRIGHTTEK reserves the right to make changes without further notice to any products herein to improve reliability, function or design. QT-BRIGHTTEK does not assume any liability arising out of the application or use of any product or circuit described herein; neither does it convey any license under its patent rights, nor the rights of others.

Life Support Policy

QT-BRIGHTTEK's products are not authorized for use as critical components in life support devices or systems without the express written approval of QT-BRIGHTTEK. As used herein:

1. Life support devices or systems are devices or systems which, (a) are intended for surgical implant into the body, or (b) support or sustain life, and (c) whose failure to perform when properly used in accordance with instructions for use provided in the labeling, can be reasonably expected to result in a significant injury of the user.
2. A critical component in any component of a life support device or system whose failure to perform can be reasonably expected to cause the failure of the life support device or system, or to affect its safety or effectiveness.