

QT-Brightek Display Series

0.56" Single Digit Display

Part No.: QBSLDIW56ZGR

Z = 1: Common Cathode

Z = 0: Common Anode

Table of Contents:

Introduction	3
Electrical / Optical Characteristic (Ta=25 °C)	4
Pin Configuration	5
Characteristic Curves.....	6
Ordering Information	7
Revision History	8
Disclaimer	8

Introduction

Feature:

- 0.56" Single digit seven segments display
- Low power consumption
- InGaN technology
- Z= 1: Common Cathode or 0:Common Anode

Description:

These 0.56" Single digit seven segments displays are made with white segment and grey surface. The viewing distance is up to seven meters.

Application:

- Instrument panels
- Indoor/Outdoor display board
- Audio equipment

Certification & Compliance:

- ISO9001
- RoHS Compliant



Dimension:

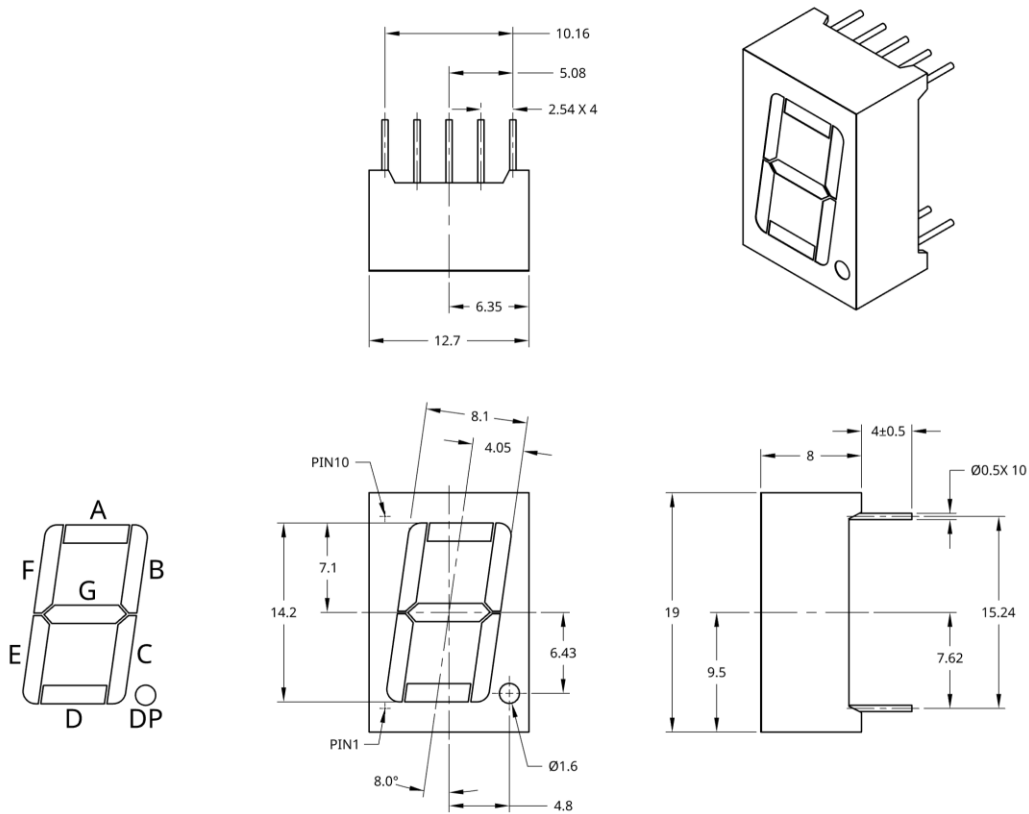

Units: mm / tolerance = +/-0.25mm

Electrical / Optical Characteristic (Ta=25 °C)

Product		Color	I _F (mA)	V _F (V)		Chromaticity Coordinates	I _v (mcd)
Common Cathode	Common Anode			Typ.	Max.		
QBSLDIW561GR	QBSLDIW560GR	White	20	3.0	3.2	X=0.30 Y=0.31	130 @10mA 260 @20mA

Absolute Maximum Rating

Material	P _d (mW)	I _F (mA)	I _{PF} (mA)*	V _R (V)	T _{OP} (°C)	T _{ST} (°C)
InGaN	64	20	40	5	-40 to +80	-40 to +85

*Duty 1/10 @ 1KHz

Pin Configuration

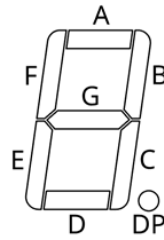

Common Cathode (QBSLDIW561GR)

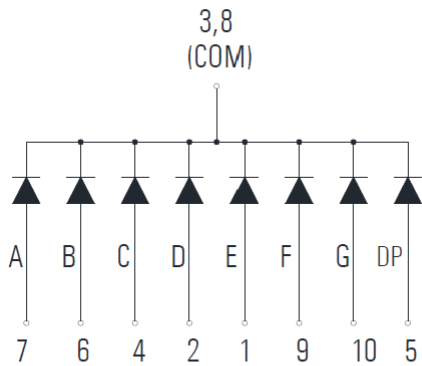

Common Anode (QBSLDIW560GR)

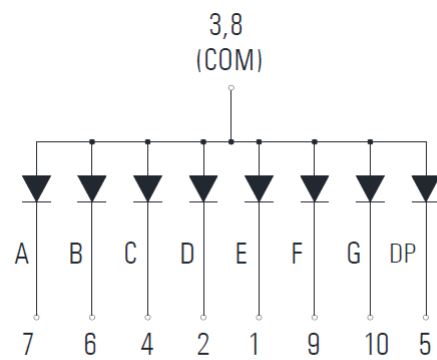

Characteristic Curves

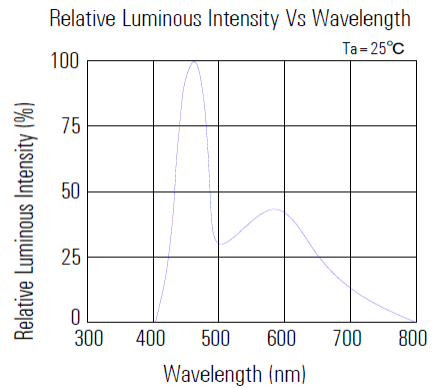
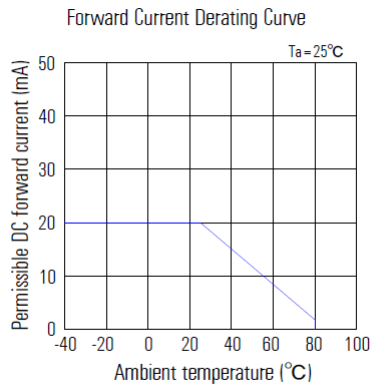
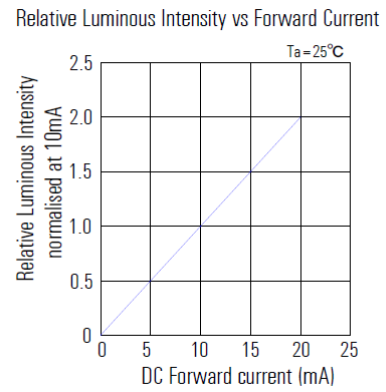
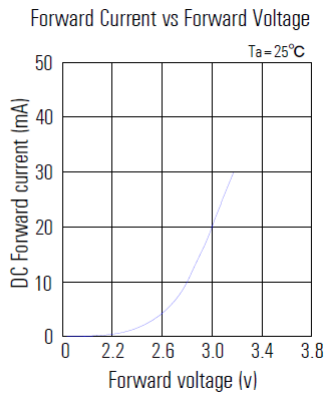



Ordering Information

Orderable Part #		Spec Range	Quantity per foam
Common Cathode	Common Anode		
QBSLDIW561GR	QBSLDIW560GR	Iv=260mcd typ. @ 20mA, X=0.30, Y=0.31	200 pcs

Revision History

Description:	Revision #	Revision Date
New Release of QBSLDIW30ZGR	V1.0	08/23/2023

Disclaimer

QT-BRIGHTTEK reserves the right to make changes without further notice to any products herein to improve reliability, function or design. QT-BRIGHTTEK does not assume any liability arising out of the application or use of any product or circuit described herein; neither does it convey any license under its patent rights, nor the rights of others.

Life Support Policy

QT-BRIGHTTEK's products are not authorized for use as critical components in life support devices or systems without the express written approval of QT-BRIGHTTEK. As used herein:

1. Life support devices or systems are devices or systems which, (a) are intended for surgical implant into the body, or (b) support or sustain life, and (c) whose failure to perform when properly used in accordance with instructions for use provided in the labeling, can be reasonably expected to result in a significant injury of the user.
2. A critical component in any component of a life support device or system whose failure to perform can be reasonably expected to cause the failure of the life support device or system, or to affect its safety or effectiveness.

Product: QBSLDIW56ZGR	Date: August 23, 2023	Page 8 of 8
	Version# 1.0	